



内観パース



縦動線スケール変化なし



横動線スケールと形態が一定の連続性で変化する

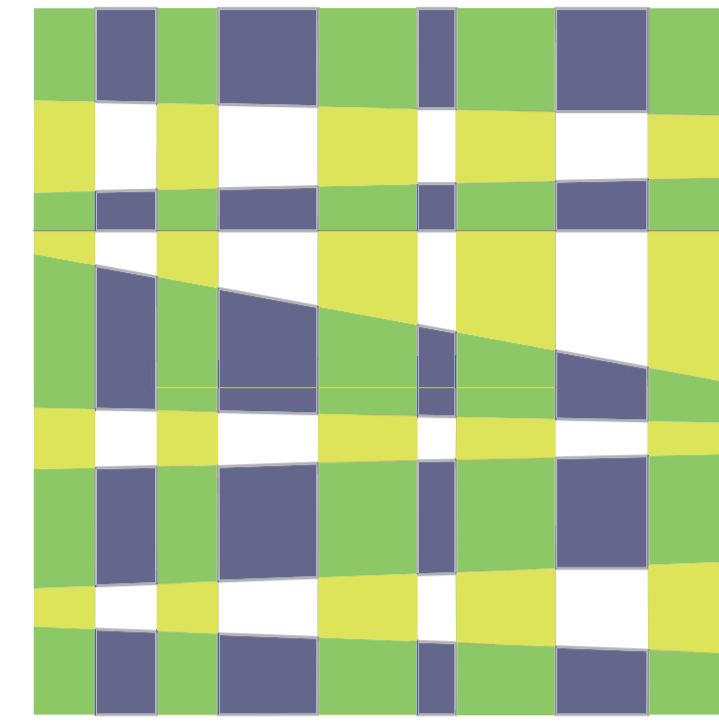

縦動線と横動線の交差

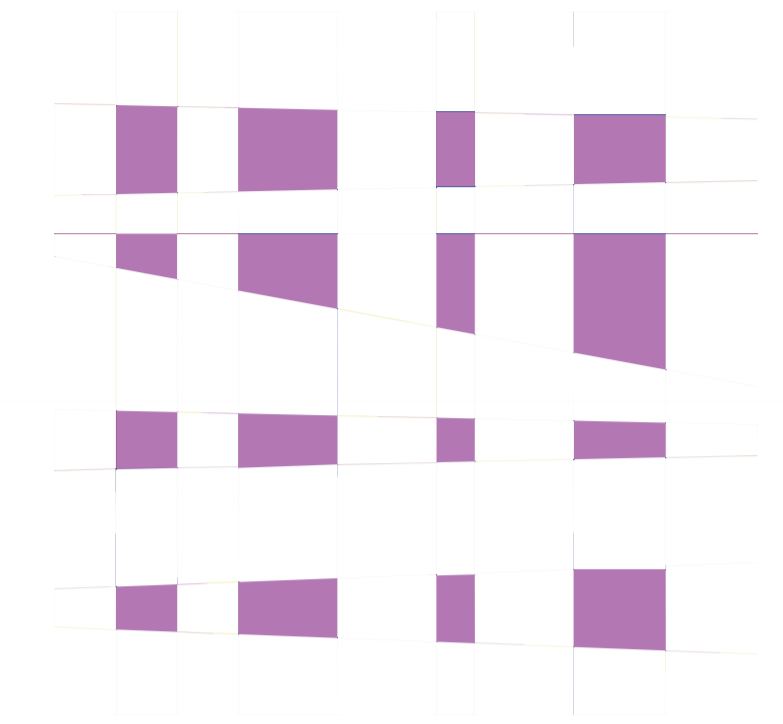

交わった空間のスケールが曖昧となる



縦動線からの空間構成



横動線からの空間構成

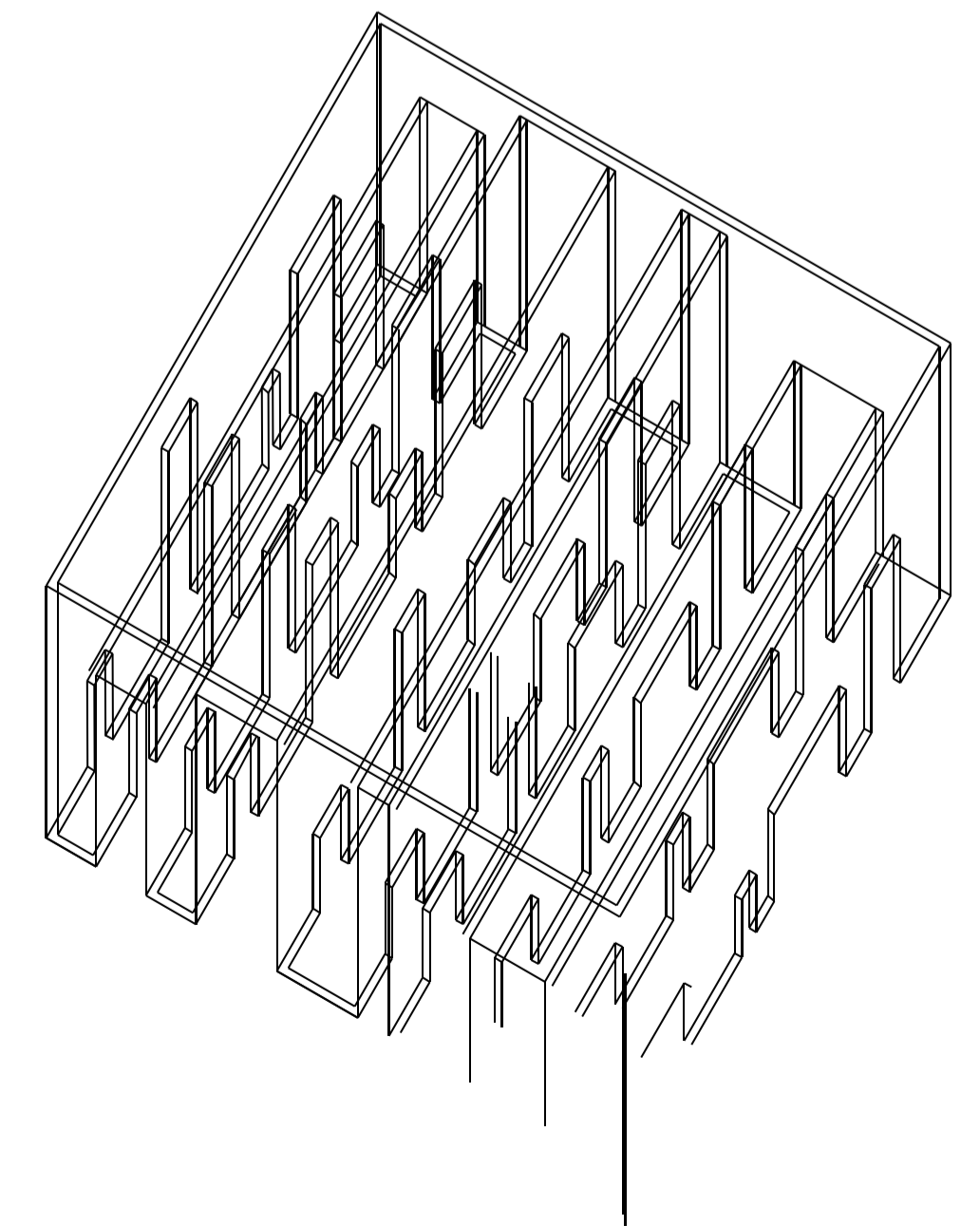
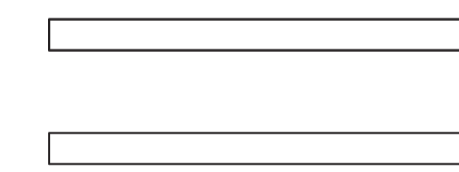
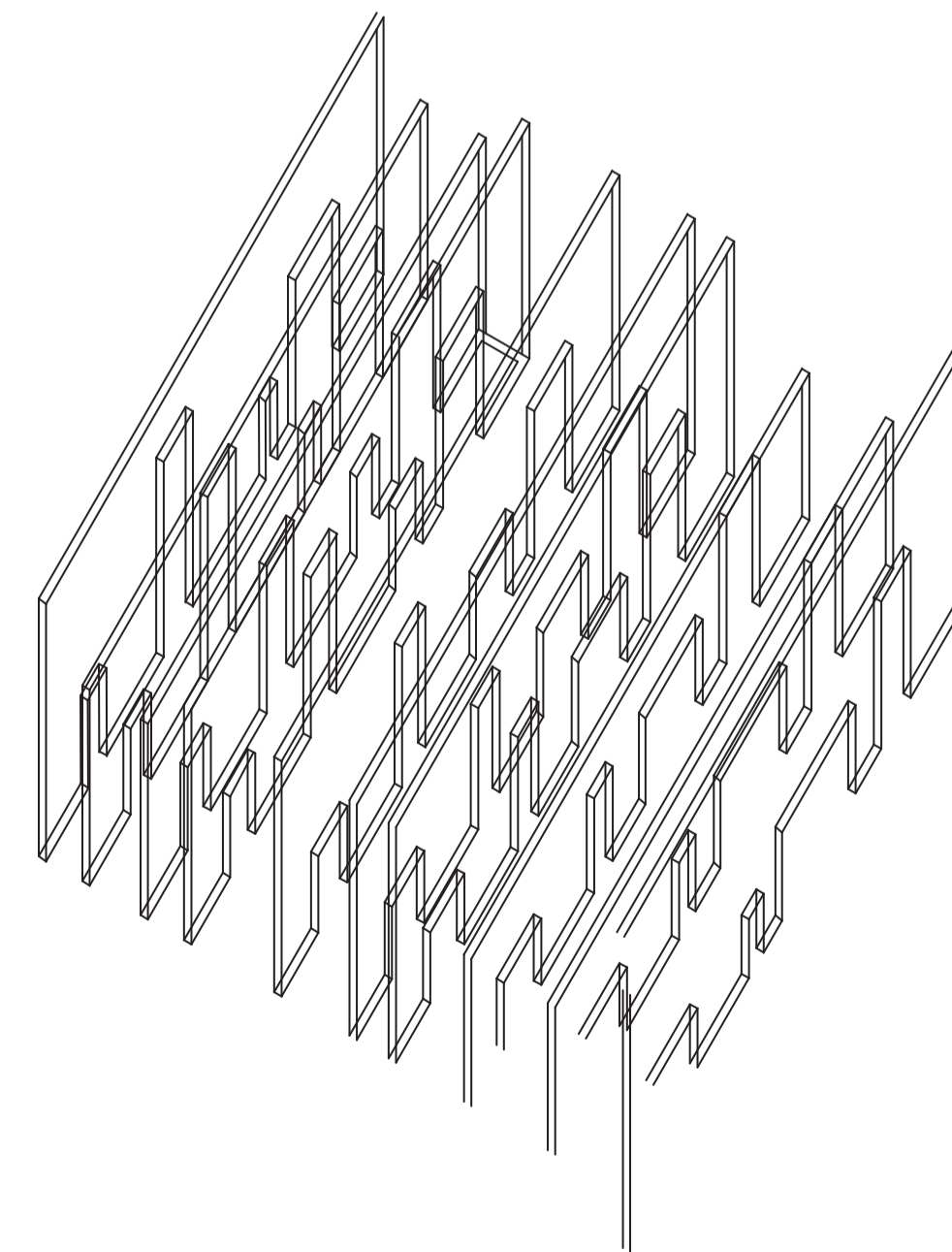
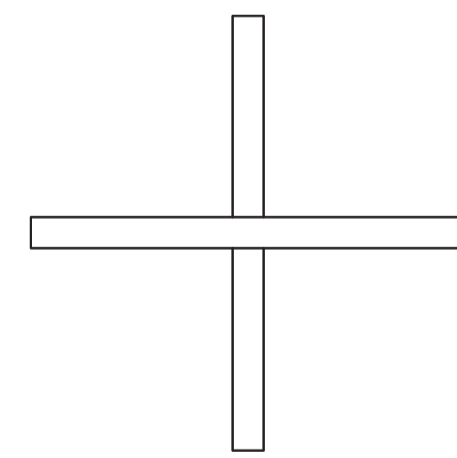
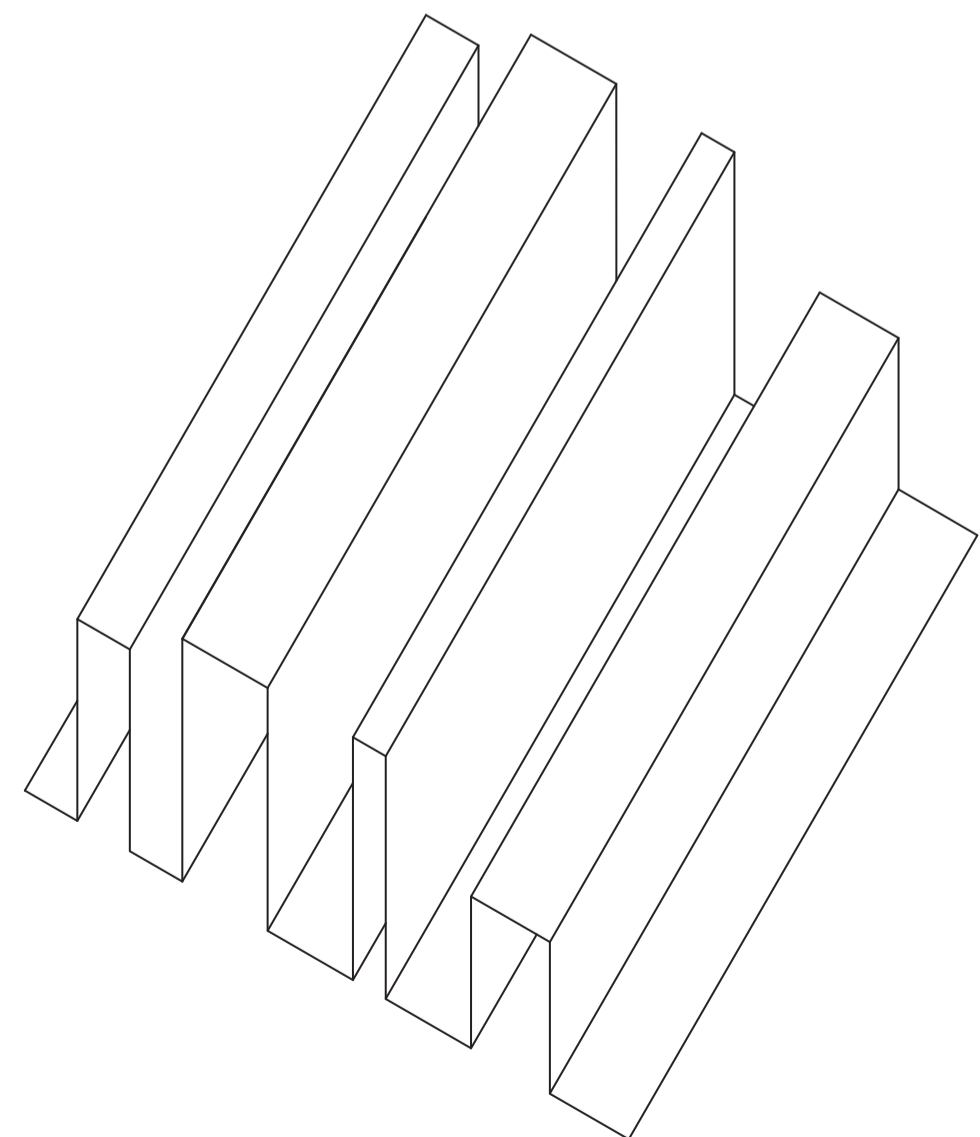

# 兩性與類

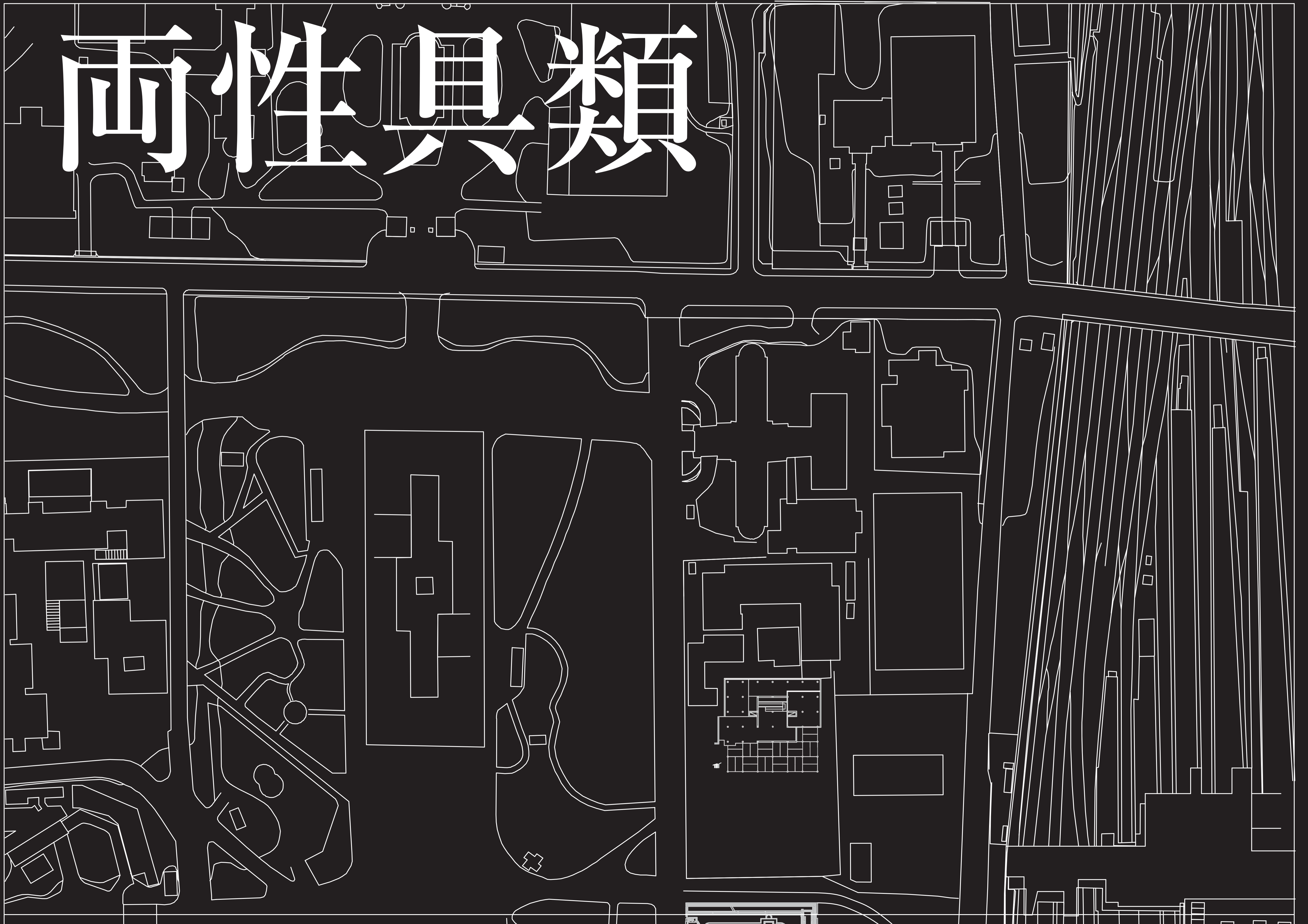

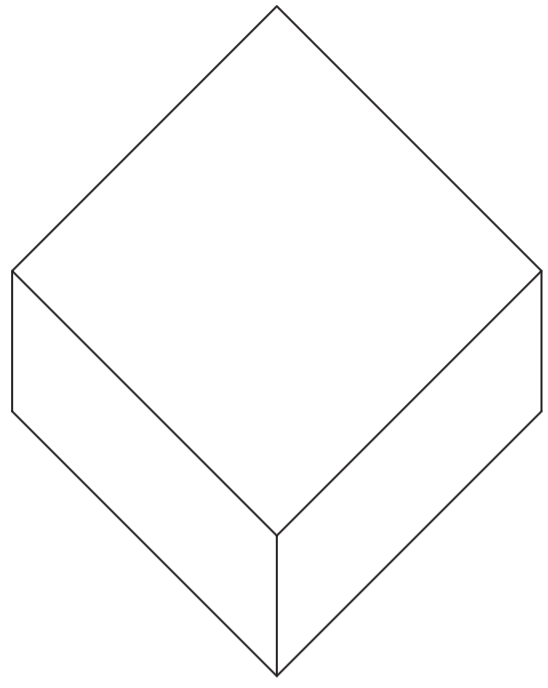

原型 周りから影響受けない状態

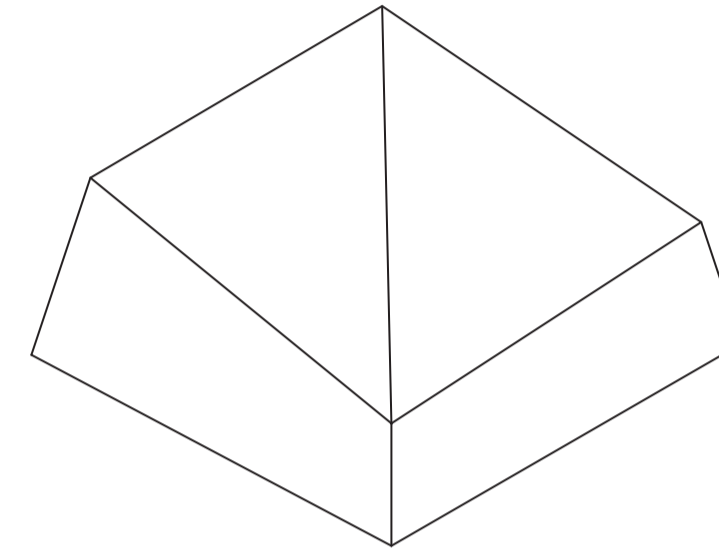

屋根の変化はまわりの建物や自然によるもの

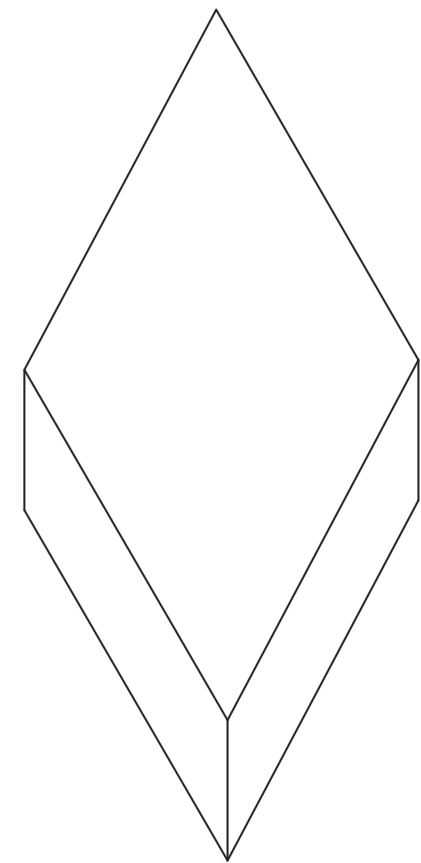

ボリュームが周辺によって影響を受けた状態

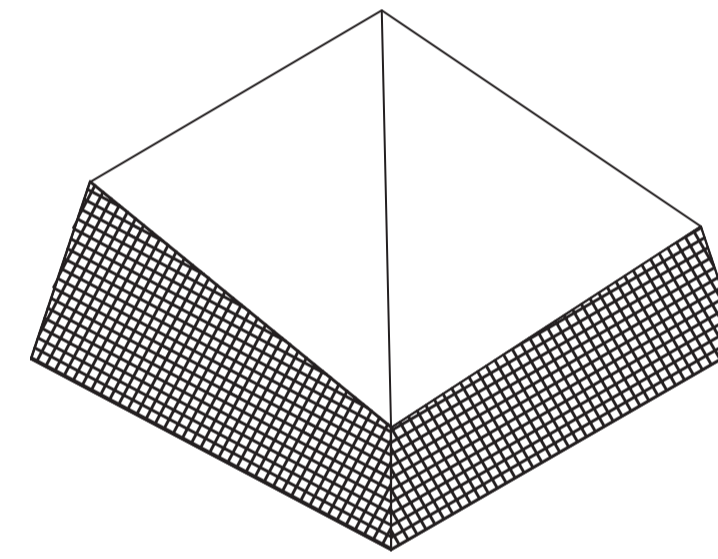

素材の変化は周りの環境や歴史などから変化する。

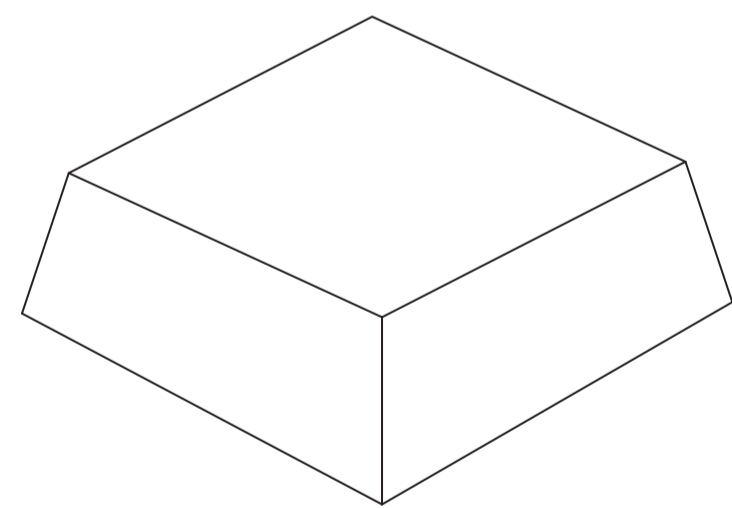

垂直な壁が変化し内側に影響する

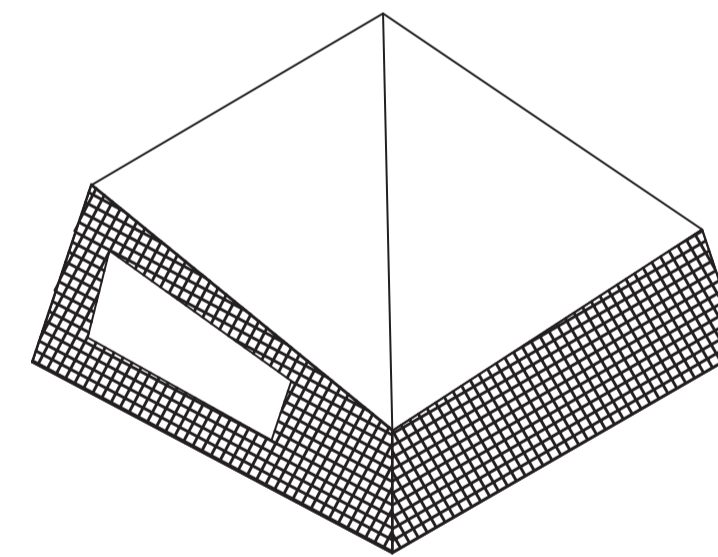

開口は建物の内側と外側による関係から変化する

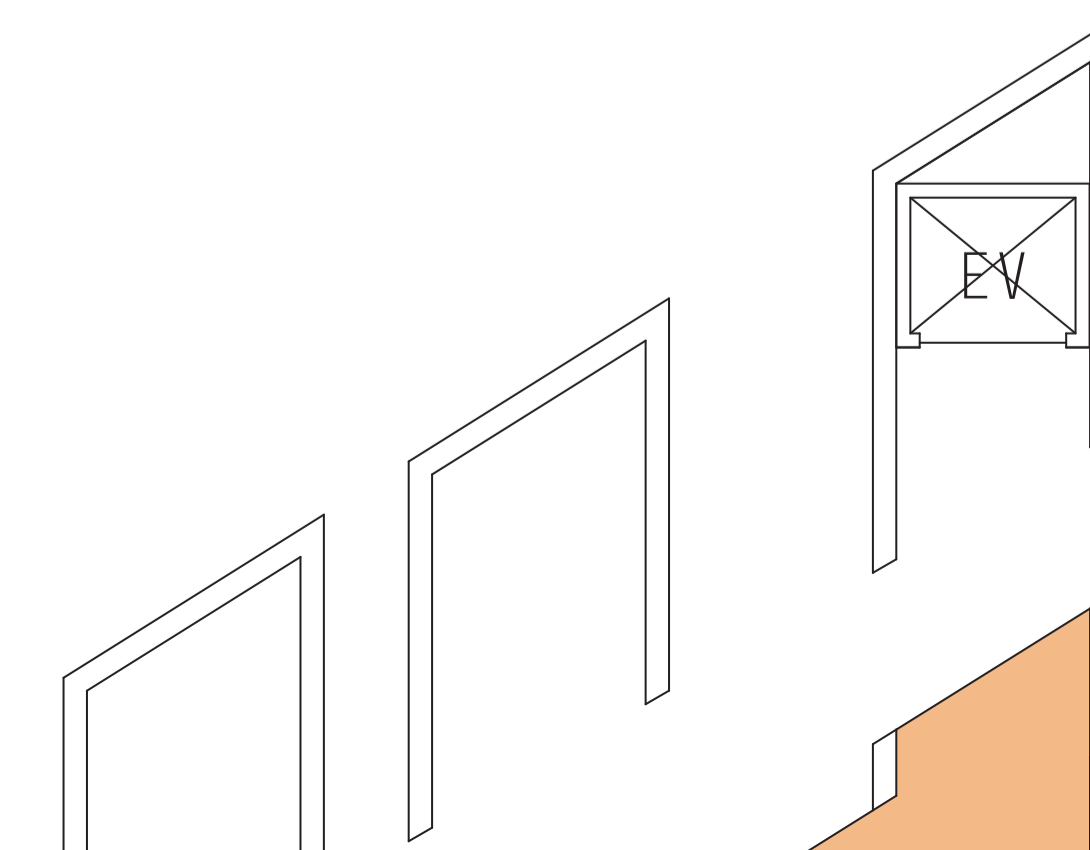
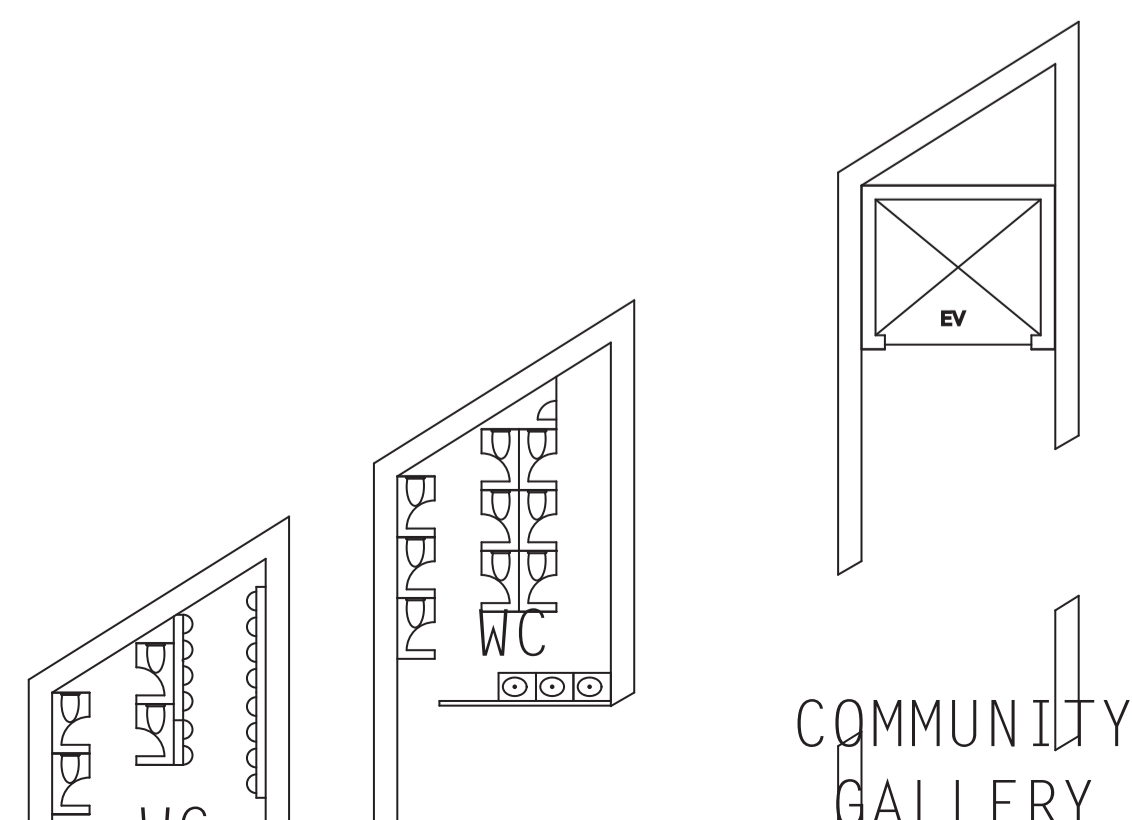



外観パース



内観パース

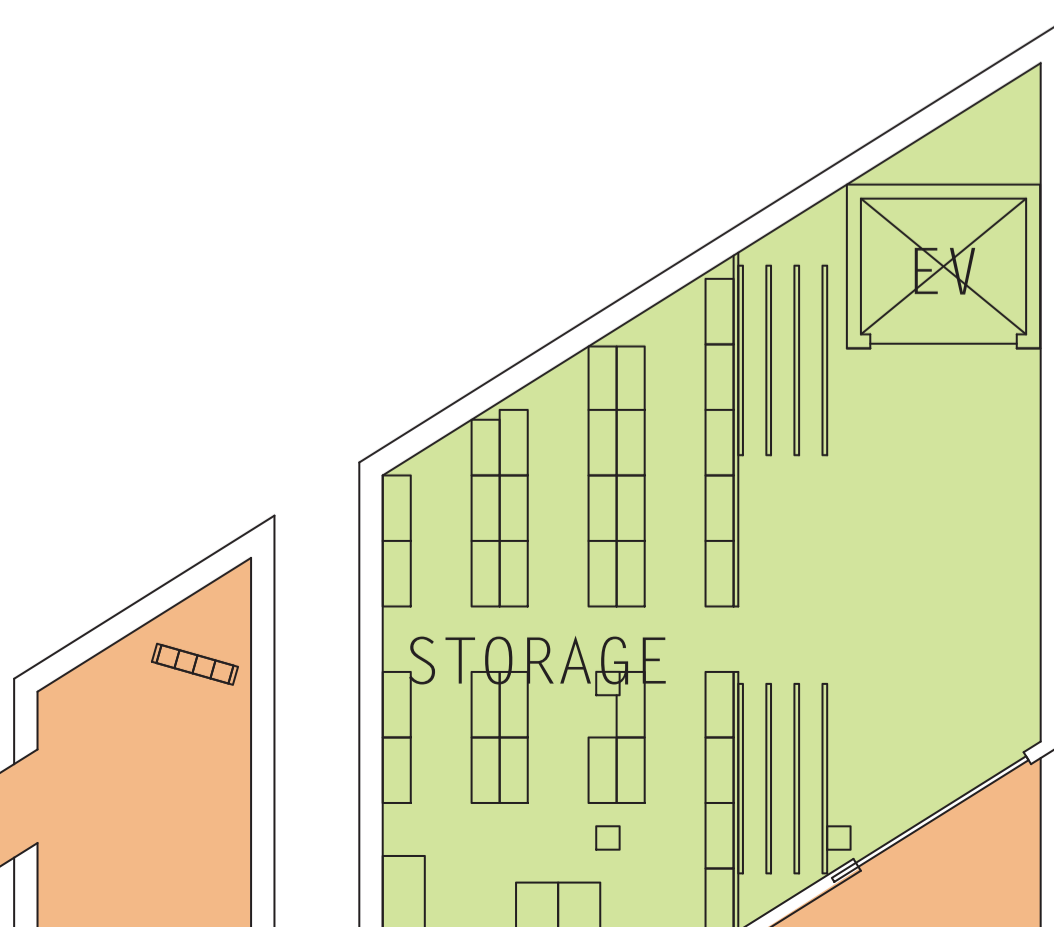

内観パース



断面模型

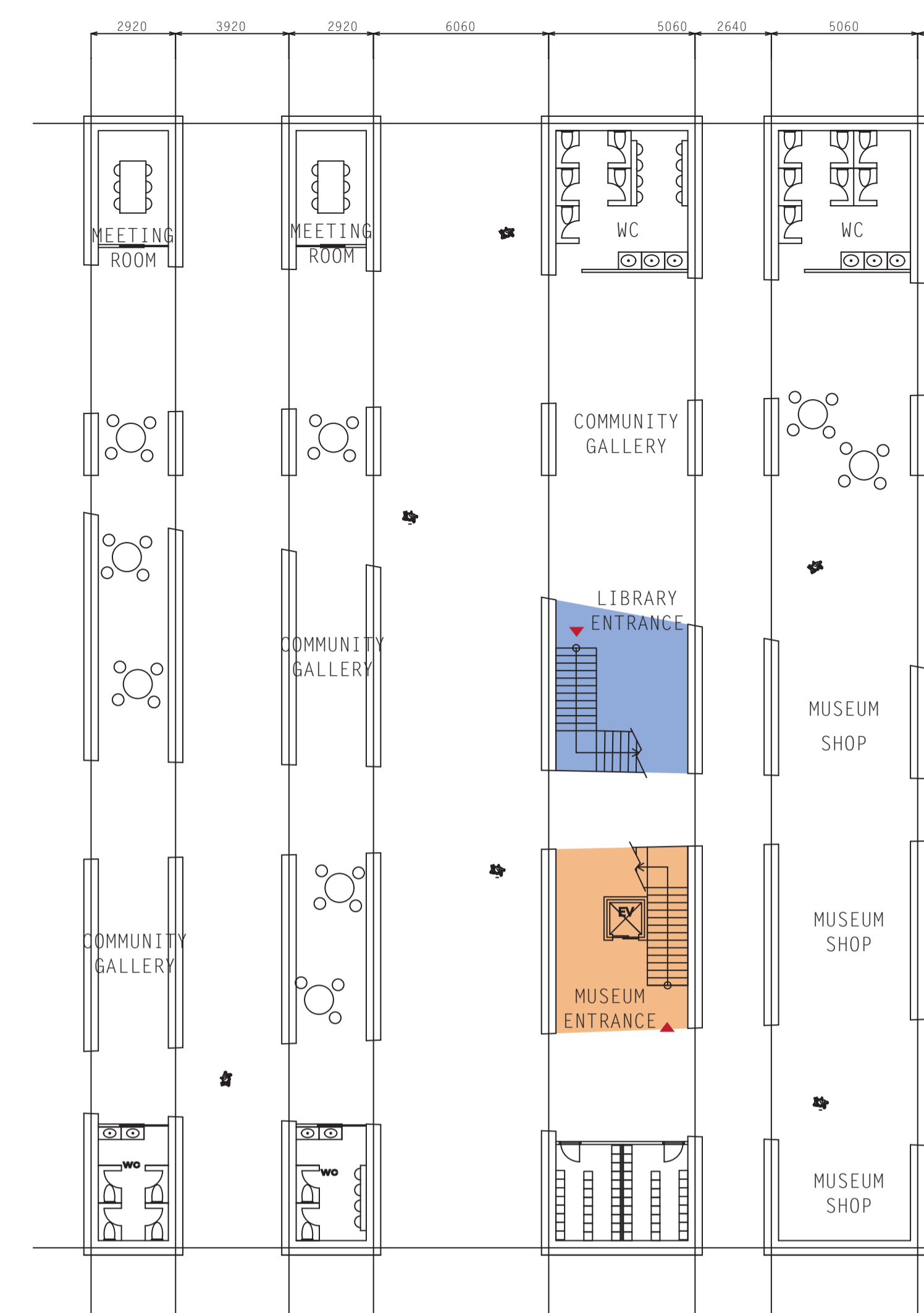

1F PLAN 1/100

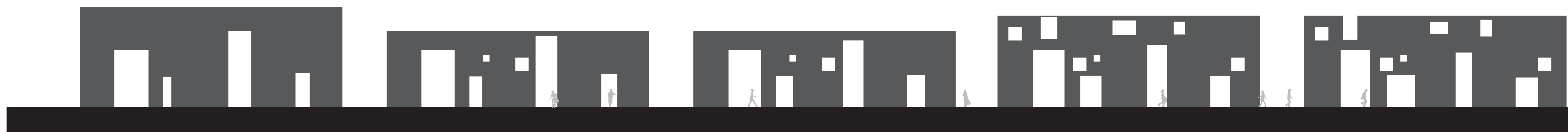
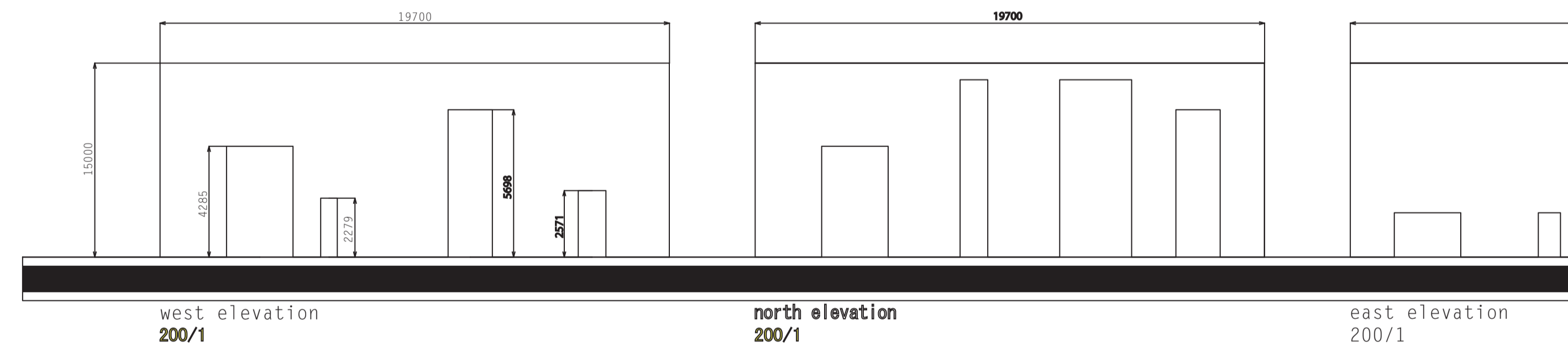

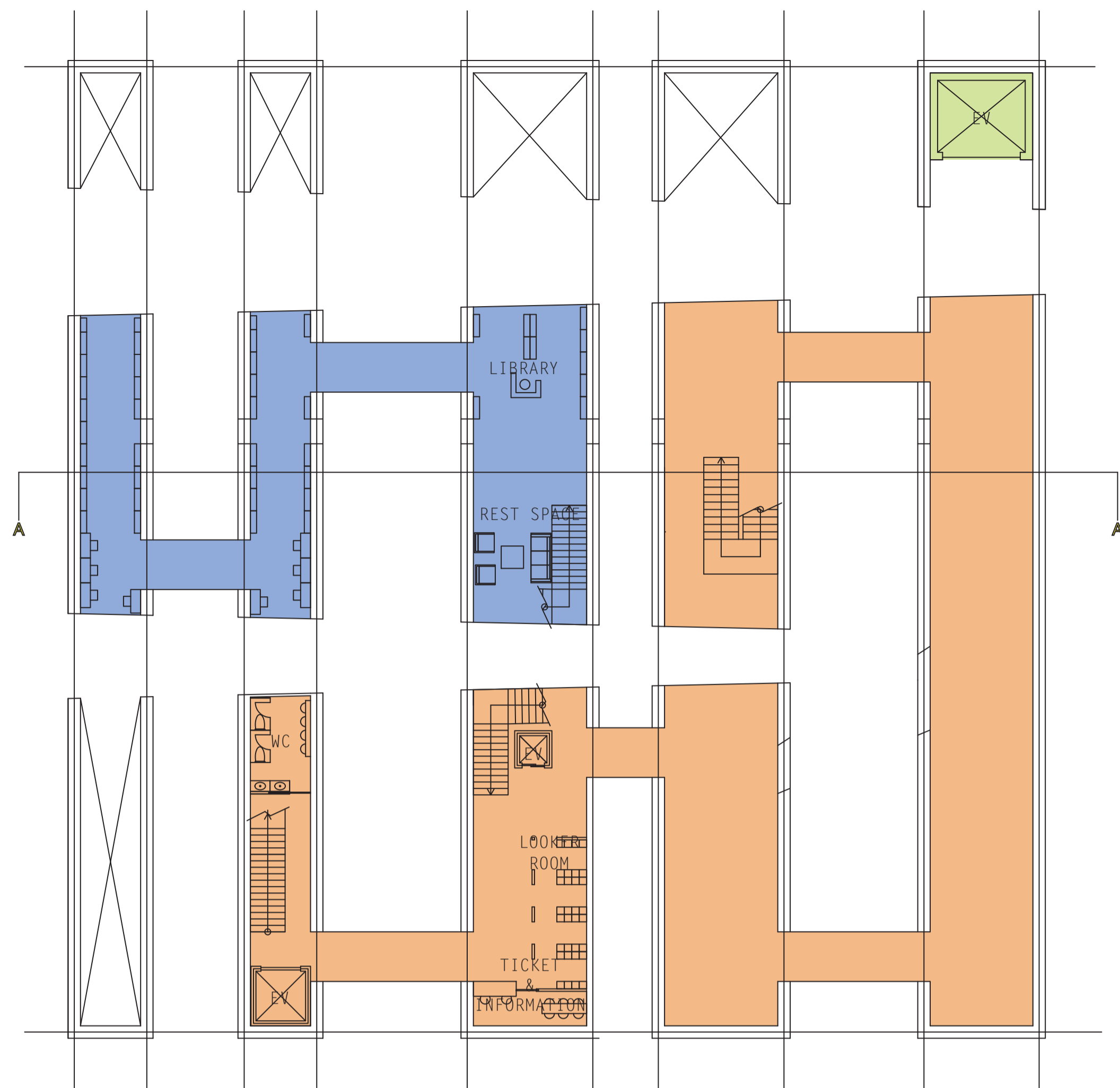
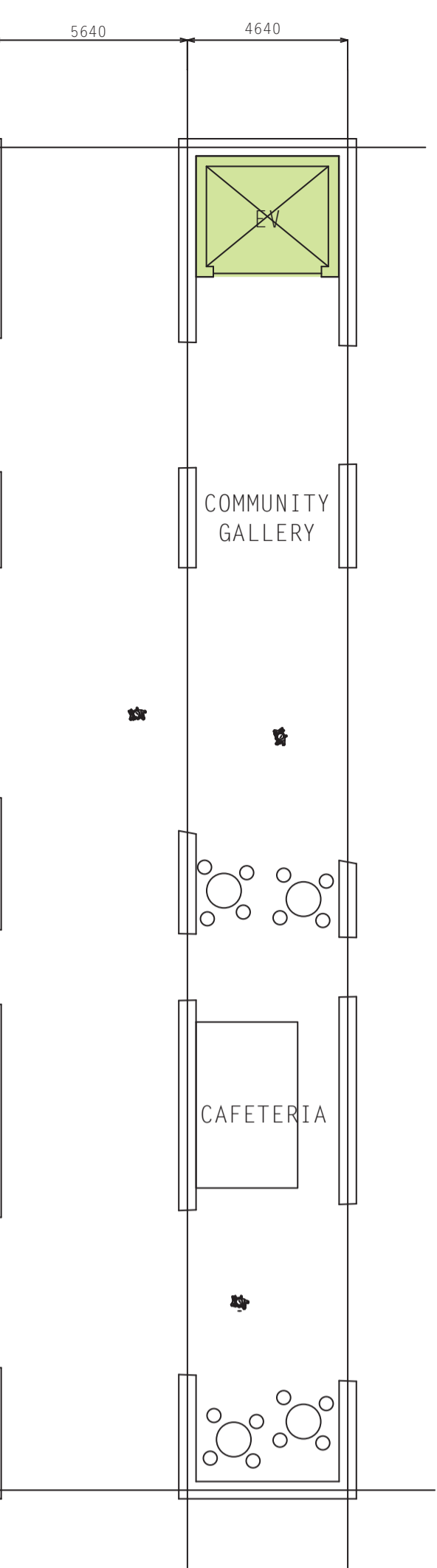

2F PLAN 1/100

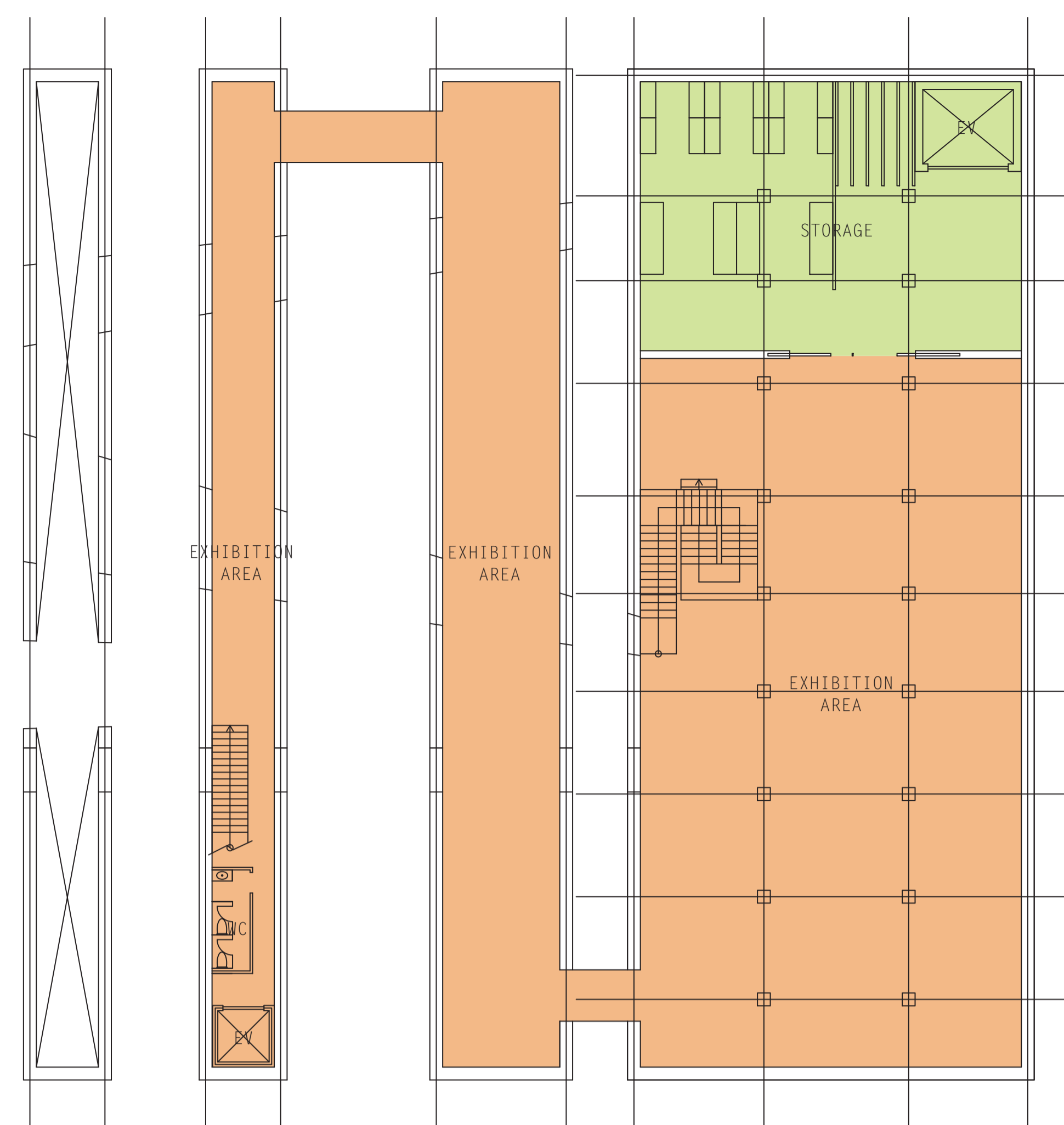

3F PLAN 1/100

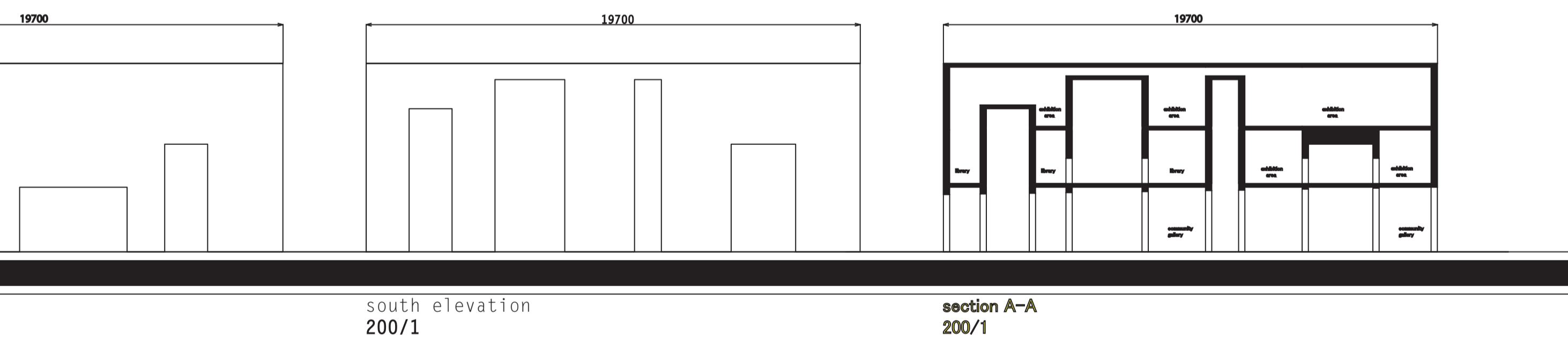

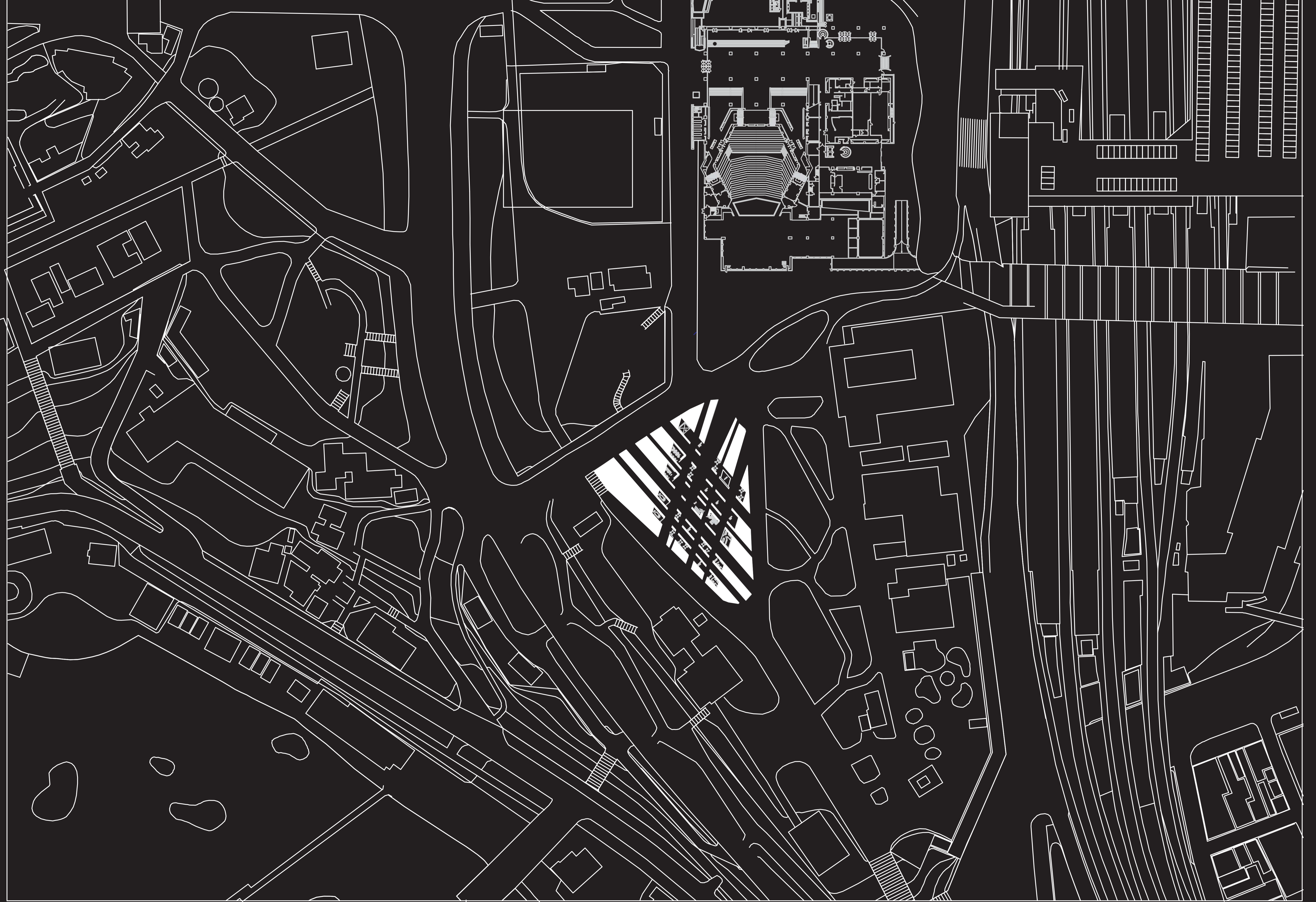

PLOT PLAN



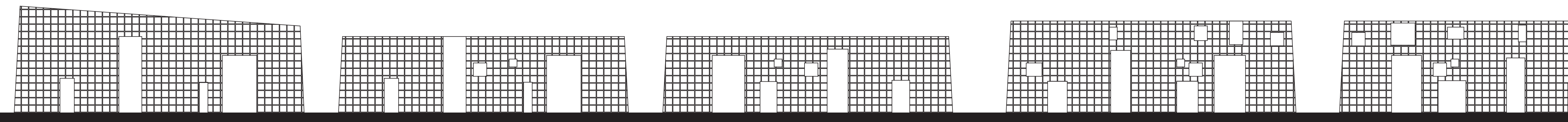
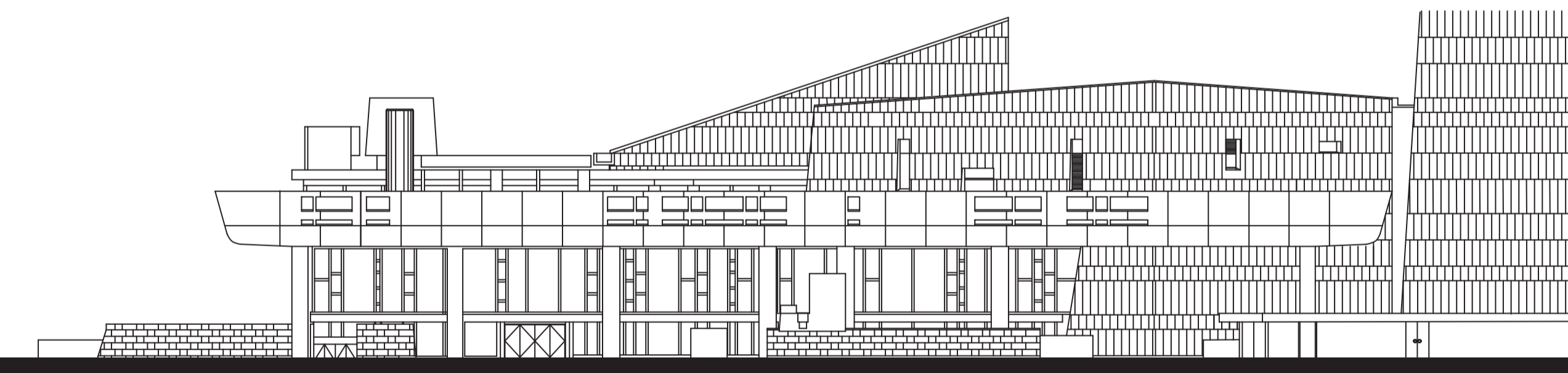
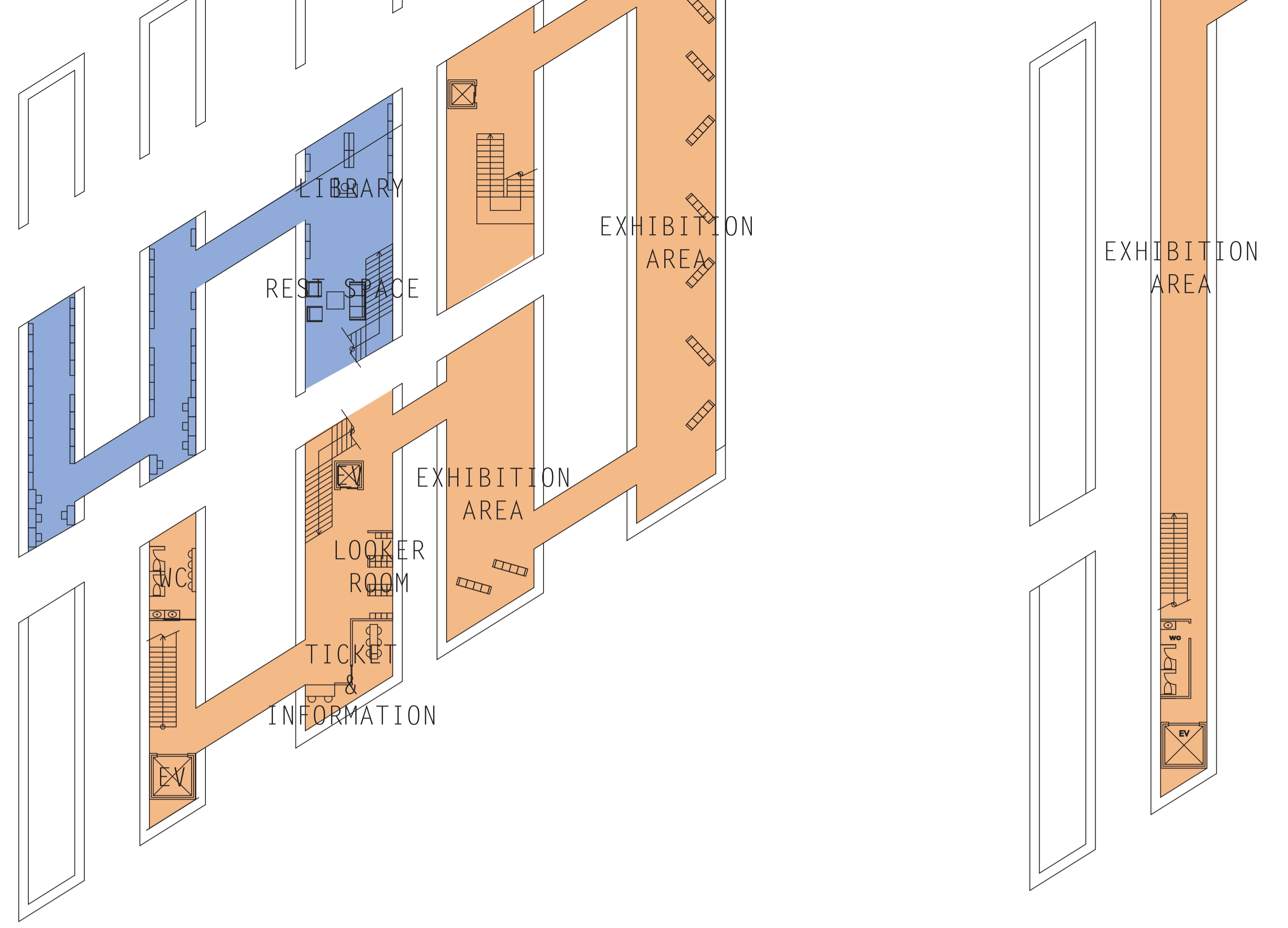
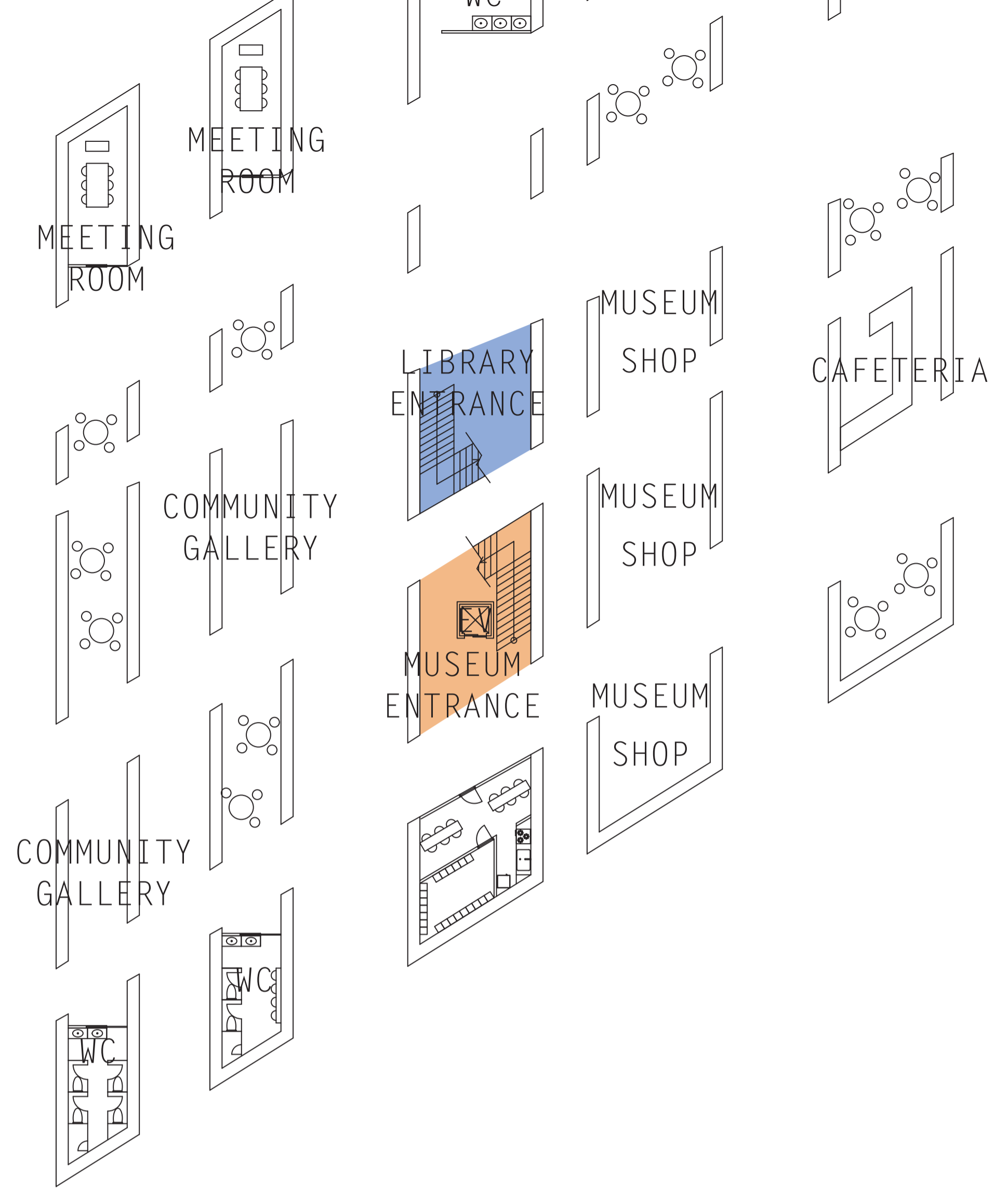

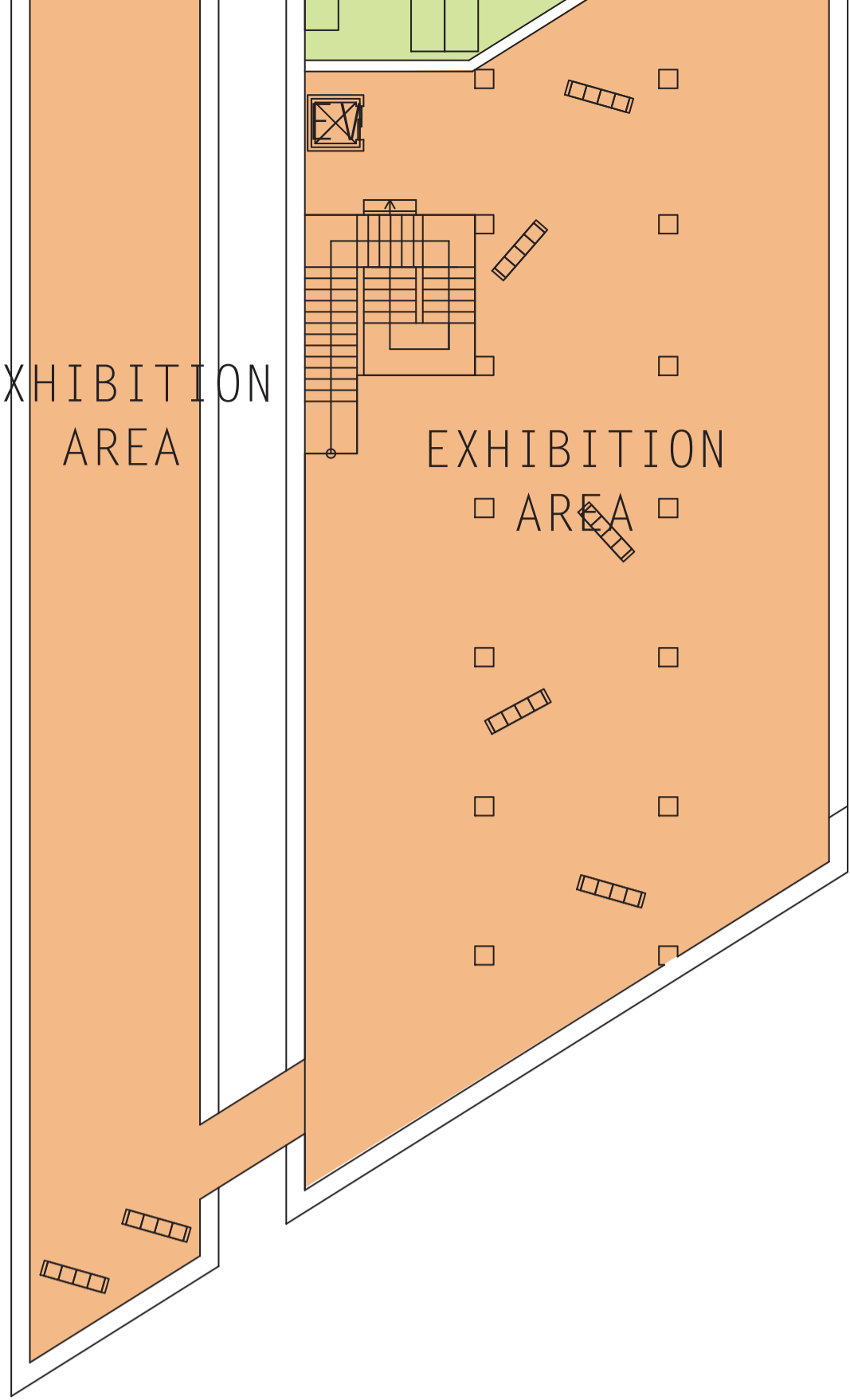

外観パース

